



# 2006 ExtraOrdinary Technology Conference

Salt Lake City, UT --\$-- July 27-Jul 30

## CONFERENCE PROGRAM

### MEET THE SPEAKERS

- Dr. David Korn
- Jeff Behary
- Oliver Nichelson
- Frank Germano
- Ralph Suddath
- Larry Oja
- Thorsten Ludwig
- Moray King
- Ron Nott
- Mike Windell
- William Alek
- Forrest Pittman
- Vernon Roth
- Dan Davidson
- Harvey Fiala
- Peter Lindemann



**Get UP CLOSE...  
& Personal  
with Working Hardware!**

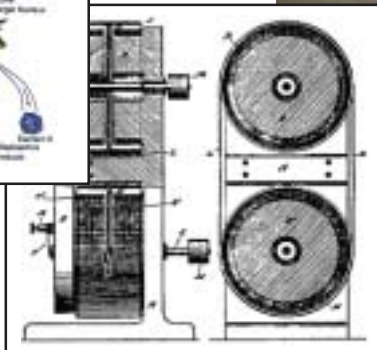
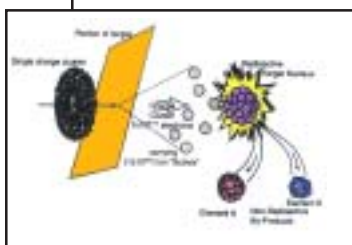
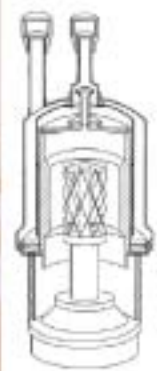

**Theory &  
Construction!**



**Become A  
TeslaTech  
Member  
TODAY!!!**

**(520) 463-1994**



# 2006 ExtraOrdinary Technology Conference

Miller Free Enterprise Center • Salt Lake City • July 27- July 30, 2006

## CONFERENCE PROGRAM OVERVIEW

VIDEOTAPES WILL BE AVAILABLE AFTER CONFERENCE!

*TeslaTech, Inc reserves the right to make changes to this schedule without notice.*

### Thursday • July 27

#### Session 1 (Evening) • An ExtraOrdinary Hazard!

5:00PM: **Dr. David Korn** - Identifying and Treating End Time Diseases

7:00PM: *Conference Evening Social*

### Friday • July 28

#### Session 2 (Morning) • Researching Tesla's Inventions

8:00AM: **Jeff Behary** - Nikola Tesla's "Tesla Coils"

9:30AM: **Oliver Nichelson** - Tesla's Dynamo Electric Machine

11:00AM: **Frank Germano** - Tesla's ExtraOrdinary Bladeless Disc Turbines

#### Session 3 (Afternoon) • Advanced Water Technology

1:00PM: **Ralph Suddath** - Aqua Jewel: The Crown Jewel of Water Conditioning

2:30PM: **Larry Oja** - Browns Gas... Fire from Water

4:00PM: **Thorsten Ludwig** - Excess Heat with Hydrogen Tube

#### Session 4 (Evening)

6:00PM: *Conference Evening Social*

### Saturday • July 29

#### Session 5 (Morning) • Zero Point Energy Technology

8:00AM: **Moray King** - Cascade Electric Discharge for ZPE Activation

9:30AM: **Ron Nott** - The Power In Space

11:00AM: **Mike Windell** - Enhanced Energy Conversion Device (Day/Night "Solar Cell"!)

#### Session 6 (Afternoon) • Alternative Energy Technology

1:00PM: **William Alek** - A Spark Gap Method of Harnessing Radiant Energy

2:30PM: **Forrest Pittman** - Power Factor Correction Makes Every Watt Count

4:00PM: **Vernon Roth** - Joe Cell... Suppressed Technology from the 'Land Down Under'!

#### Session 7 (Evening)

6:00PM: *Conference Evening Social*

### Sunday • July 30

#### Session 5 (Morning) • 21st Century Technology

8:00AM: **Dan Davidson** - Antigravity Effects in Nature

9:30AM: **Harvey Fiala** - Inertial Propulsion Paradigms

11:00AM: **Peter Lindemann** - Radiant Energy & Its Role In Our Free Energy Future

## Thursday · July 27 · Session 1 (Evening) · An ExtraOrdinary Hazard



### Identifying & Treating End Time Diseases

**David Korn DDS, DO, MD(H)**

The fastest-growing epidemic in the world.... Lyme Disease... is now on six continents and spreading fast. Everyone should be greatly concerned. It has been published that over 300 dissimilar disorders are linked to the Lyme bacterium, most of these very serious.

It lurks in the background of a number of serious conditions like MS or perhaps Parkinson's. A first cousin to syphilis, not only is the elusive Lyme bacterium tough to diagnose, but also underestimated by health care practitioners.

How did Lyme Disease get to be such a pain? Where did it come from? What causes it? These have not been as easy to answer as one might think, even given modern epidemiologic detective work.

Truly the disease could not be any "better" of a disease, were it designed by the devil himself.

In fact, most Christians and escatologists—those Bible scholars who specialize in prophecy—and the speaker, strongly hold that we are living in the "End Days." If that is, in fact, true, one could expect to see signs of this around us: plagues and natural disasters would abound. Indeed, are they not?

The speaker sees Lyme Disease—the world's fastest growing epidemic—as fulfilling "plague" end-day requirements! Learn more about the origins of some modern day plagues, how to positively identify and effectively defeat this disease. *Your health may depend on it!*

## Conference Lodging Facilities

Limited space... Please register by June 30!



Be sure to request our special *TeslaTech Conference rates!*



**Hampton Inn**  
10690 S Holiday Park Dr  
Sandy, UT 84070

**Hotel Reservations:**  
**(801) 571-0800**

**Hotel Amenities**  
For comfort and convenience,  
hotel amenities include:

- Free Shuttle service within a 5-mile radius (includes conference site)
- Free Breakfast Bar
- Free local calls/no surcharge on cards
- Clean, fresh, comfortable rooms standard with a coffee maker, iron and ironing board, data port, and free in-room movie channel
- 24-hr FAX and copy services

### Airport Shuttle Information



Express Shuttle *Check-in Desks* are inside the terminal. Please do not go outside to the curb.

**Reservations: 1-800-397-0773**  
Local Reservations: 801-596-1600

Be sure to ask for the Special *ExtraOrdinary Technology Conference Rate!!!*

### Conference Evening Social

**Meet the Speakers!**  
Thu/Fri/Sat 7PM  
Hampton Inn

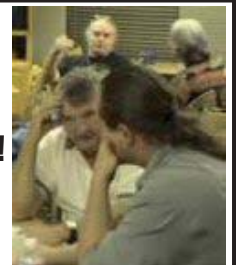

Every night provides an opportunity to meet the speakers and other attendees in a relaxed social setting. Its a great opportunity to make new friends that share your interests. We even provide the refreshments!

### Located just off I-15 (Exit 297)





## Conference Site:

### Miller Free Enterprise Center Salt Lake City Community College

**Larry H. Miller Campus**  
9750 South 300 West  
Sandy, UT 84070

### Miller Campus Directory

MPDC - Miller Professional Development Center  
KGMC - Karen Gail Miller Conference Center  
**MFEC - Miller Free Enterprise Center**  
MATC - Miller Automotive Training Center  
MCPC - Miller Corporate Partnership Center

#### Driving from The North:

Take I-15 South to Exit 298 (9000 South). Exit right (west) onto 9000 South and proceed to 450 West (1st light). Turn left (south), go to 9120 South & turn left (east), go to 300 West (frontage road) & turn right (south). Proceed 6 blocks south along frontage road.

#### Driving from the South:

Take I-15 North to Exit 297 (10600 South) after exiting, turn right (east) and proceed to State Street. Turn left (north), go to light at 10000 South (Centennial Way) in Sandy. Turn left (west), go under I-15 & turn right (north) on 300 West (frontage road). Proceed 2 blocks north along frontage road.

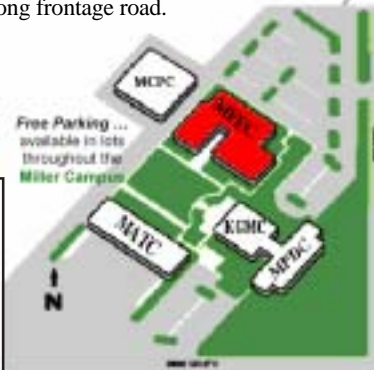

## DVD CONFERENCE SETS AVAILABLE!!!

### 600640 - 2005 Complete Conference Set (19 DVDs) ..... 299.95

Jeff Behary • Pat Flanagan • Steven Haltiwanger • Gene Koonce • Tim Ventura  
Don Smith • Larry Deavenport • Tom Valone • Harvey Fiala • Thorsten Ludwig  
Bob Patterson • Hal Fox • Vern Roth • K Chukanov • Sterling Allan • Pat Bailey  
Moray King • Paul Pantone • Bill Alek

### 600540 - 2004 Complete Conference Set (Includes 20 DVDs) .. 299.95

Larry Oja • Glen A. Gordon • Bruce Forrester • Tony Cocilovo • Konstantin Meyl • Sonne Ward • Moray King  
Tom Valone • Kiril Chukanov • Bruce Perreault • Alan Francouer • John Balfour • Dale Pond • Hal Fox  
Bob Patterson • Dan Davidson • Paul Pantone • Vladimar Ginzburg • Thorsten Ludwig • Jan Marwan

### 600455 - 2001 Complete Conference Set (Includes 15 DVDs) .. 224.95

Gerard Judd • Elinor Gibbs • Ron McElroy • Russ Rasnic • Paul Pantone • Al DePena • Hal Fox  
Andreas Richter • Doug Konzen • Bruce Perreault • Jim Cox • Sonne Ward • Chuck Parker  
Brian O'Leary • Clifford Smith

### 600356 - 2000 Complete Conference Set (Includes 15 DVDs) .. 224.95

Pat Shannon • Susan Gordon • Bruce Gerlator • Elinor Gibbs • Paul Pantone • Bruce Perreault  
Tyler Pauley • Doug Konzen • George Wiseman • Marc Seifer • Jone Schramm • Bob Colvin  
Lyn Kinny • Sonne Ward • Dan Davidson

### 600254 - 1999 Complete Conference Set (Includes 20 DVDs) .. 299.95

Ron Waling • Jim Bare • Dan Kunkel • Elinor Gibbs • Jesse Grenier • Don Isaac • Paul Pantone  
Steven Ammerman • Joseph Bender • Walter Rawls • Brian Andersen • Tom Valone • Bill Beaty  
Dan LaRochele • Rick Todish • Bruce Perreault • Jeff Hayes • George Wiseman • B Perreault

### 600156 - 1998 Complete Conference Set (Includes 24 DVDs) .. 359.95

Mary Stoddard • Pam Golden • Bill Eidelman • Dan Kunkel • Terry Hull • Anne Tracy • Ron Kovac Sonne  
Ward • Dean Viktora • Paula Randal • Ralph Suddath • Brian Andersen • Dan Davidson  
George Wiseman • Bruce Perreault • Calvin Bahlman • Paul Pantone • Jim Diletto • Nelson Camus  
Rick Koskela • Paul Brown

**Single DVDs: \$29.95 for 2006 Conference... \$19.95 for Previous Conferences!**



**ALL Sets Packaged in Book-style DVD Wallets with vinyl sleeves!**

### 600740- 2006 Conference Set (16 DVDs) ..... 399.95

#### Individual 2006 DVDs \_ 29.95ea.

Dr. David Korn .....	600721
Jeff Behary .....	600722
Oliver Nichelson .....	600723
Frank Germano .....	600724
Ralph Suddath .....	600725
Larry Oja .....	600726
Thorsten Ludwig .....	600727
Moray King .....	600728
Ron Nott .....	600729
Mike Windell .....	600730
William Alek .....	600731
Forrest Pittman .....	600732
Vernon Roth .....	600733
Dan Davidson .....	600734
Harvey Fiala .....	600735
Peter Lindemann .....	600736

**VHS Available by Special Request!**

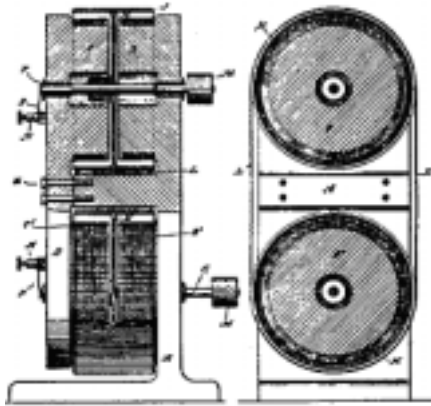

## **Nikola Tesla's Fuelless Generator**

**Oliver Nicholson**

While in college, Nikola Tesla claimed it should be possible to operate an electrical motor without sparking brushes. He was told by the professor that such a motor would require perpetual motion and was, therefore, impossible. In the 1880s, Tesla patented the alternating current generator, motor, and transformer we use today.

Ten years after virtually inventing modern electrical technology, Tesla claimed he developed a generator that would not "consume any fuel." Such a generator would not have a conventional source of energy such as oil, coal or falling water. This new generator would get energy from what he called the "ambient medium." He described this source in 1933:

This new power for the driving of the world's machinery will be derived from the energy which operates the universe, the cosmic energy, whose central source for the earth is the sun and which is everywhere present in unlimited quantities.

For nearly 100 years researchers have sought the design for Tesla's "free energy" generator. During the entire time, controversy has reigned with many "experts" disputing Tesla's claims. To be sure, hard information on this device is extremely difficult to find. However, clues, in Tesla's own handwriting, to the nature of his fuelless generator and how it operated have been uncovered!

## **Tesla's Tesla Coils Defining a Tesla Coil using Nikola Tesla's standards.**

**Jeff Behary**

The modern definition of a Tesla Coil is drastically different than that which is represented in Nikola Tesla's series of High Frequency patents. To better understand Tesla Coils, and how they operate it is vital to study the earliest working models of these coils created by Tesla himself. These devices could operate on alternating or direct currents, utilizing a variety of voltages from 110V to 220V.

The coil to the right is a reproduction of one of the three different styles of these coils. These coils consume from 5 - 20 watts from a 110V power source and produce up to a shower of 4" sparks. These devices supply more than enough power for the average Crookes tube, yielding penetrating Röntgen Rays - one of the many functions envisioned by Tesla for the practical use of these devices.



This presentation is a rare tour of "Forgotten Tesla Technologies" from the 1890s. Discover the apparatus that defined the term "Tesla Coil" as originally described by Nikola Tesla. Included will be photos/films of period apparatus as well as a rare look at the earliest surviving Tesla Coils from 1896-1901.



## **Tesla's ExtraOrdinary Bladeless Disc Turbines!**

**Century Old Technology  
Gains New Life with  
Modern Applications!**

**Frank Germano**

The Tesla Turbine is a true, highly efficient mechanical transformer of energy that is little understood in the world of orthodox physics. This presentation is a Tesla turbine builder's dream as we will delve into proper Tesla turbine construction techniques. Getting the basics straight is always essential to understanding the turbine's operating principles.

Once the basics are covered, we will examine Nikola Tesla's infamous *valvular conduit* design and how it integrates with the turbine's operation. Its unique appearance brings to mind Viktor Schauberger's work with vortexian water flows. We will make comparisons between the Tesla Turbine and Schauberger's "Repulsine" (Implosion Engine).

The Tesla Turbine can also be run in REVERSE! Conventionally, the turbine is run from fluid entering the disks' periphery, and exhausting at the center. By operating it in REVERSE it becomes an extraordinary pump!

This is an amazing pump, with a number of critical applications where fluids and other materials need to be moved without shearing forces. This device is also extremely effective in pumping slurries.

Tesla's turbine/pump has not achieved its full potential due to a number of myths. For instance, current conventional research claims that the Tesla Turbine is inefficient, we will prove otherwise. Furthermore, we will reveal what is really happening in between those disks!



# TeslaTech Books By Mail

Home of the Best Kept Secrets of Science



## Building a Tesla Turbine

by **Vince Gingery**

Even though Tesla's 1909 turbine was

never commercially available, the turbine nevertheless has generated a great deal of interest the past few years. Vince Gingery built a small, working turbine that will easily turn 5000 rpm. Here you get Tesla background, a copy of his patent, a description of the invention, and most importantly, detailed instructions and how-to so that you, too, can build a working miniature.

The turbine is built up from 18 disks of 20 gauge stainless steel. The rotor slips into a sheet metal housing and fed air through a simple manifold and hardware store piping. Two high speed bearings rated to 30,000 rpm were obtained from different internet sources for \$2-\$3 each. Driven with 85 psi of compressed air, this turbine really whistles. You can build a Tesla turbine. Simply. No hype! Do it today with minimal tools.(48pp)

260017 - Building Tesla's Engine ..... 9.95



## TESLA'S ENGINE A New Dimension for Power

Compiled by  
**Jeffery A. Hayes**

Journey back to the future and discover the fascinating secret behind the most powerful and economic combustion engine of our time: Tesla's whirlwind machine of natural harmony. Experience the excitement of understanding, as the vortex energy of a perfectly controlled mechanical tornado, shatters the boundaries of our current mechanical standards. This amazing engine will improve all aspects of our mechanical life. Applications range from high mileage vehicles and supersonic aircraft, to freon-free air conditioning, and virtually indestructible pumps. Tesla's Engine waits ready to solve the efficiency and pollution problems of today. Index

310050 - Tesla's Engine ..... 19.95

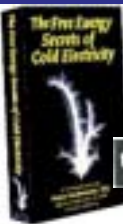

## Free Energy Secrets of Cold Electricity

Now on DVD!

In the 1970's, inventor Edwin Gray developed an electric automobile engine that produced 80 horsepower and recharged its own batteries. It ran on what he called "cold electricity." This amazing technology remained shrouded in mystery until September 2000. This video is the complete technical lecture given by Dr. Peter Lindemann at that time. In it, he explains exactly how Ed Gray's system works, how he produced "cold electricity" and how that relates to Nikola Tesla's earlier discovery of "Radiant Energy". Using 50 slides of articles, patents, photos, and circuits, Lindemann documents his research, until the method is fully revealed. Now you can understand one of the most powerful Free Energy methods ever discovered. (3 hrs)

330011- Free Energy Secret (DVD) .. 29.95

330001- Free Energy Secret (VHS) .. 29.95

**You can get the book too!...**

330002- Free Energy/Cold Electric... 29.95

## Energy Machine of T. Henry Moray

Zero-Point Energy &  
Pulsed Plasma Physics

by **Moray B. King**

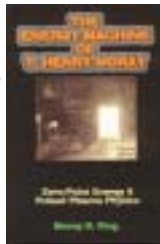

In the 1920s Moray invented a "free energy" device that produced 50 kW of electricity. Unexplainable by orthodox science, the electricity exhibited a strange "cold current" characteristic where thin wires could conduct appreciable power without heating. Moray suffered ruthless suppression. In 1939, the device was destroyed. Today, modern physics finally recognizes the vacuum contains tremendous energy called *zero-point energy*. Other inventors have discovered that it is activated by pulsing plasma, and have created novel energy devices, but they too were suppressed. The common pattern of these technologies clarified the fundamental operating principle. Free energy that works! Truly inspirational for engineers/inventors (200pp)

450003 - Energy Machine of Moray ...14.95

## Tesla's Car and Other Free Energy Devices



Compiled by **Steven R. Elswick, BSEE**

**If you are serious about building free energy devices, then this book is for you!** In addition to several different construction plans, there is plenty of background information on three different basic types of alternative energy devices. Some devices are designed merely to be more efficient than conventional technology, others claim to be overunity in the traditional sense of the word. Before you buy the mainstream physics claim that alternative energy is not possible, you should at least read the material in this book that indicates otherwise.

Supporting accounts and photos included wherever possible. This is a great book to beef up your technical library. **You will not need to be a rocket scientist to value this book.** Source material, patents and plans are right from Steve's classified file drawers.(121 pgs; GBC)

290010- Tesla's Car/Free Energy .... 29.95

## ALTERNATIVE ENERGY RESEARCHER'S REFERENCE MANUAL

## Magnetic Motors & Generators



Compiled by **Steven R. Elswick, BSEE**

Through this book you will learn:

- How to build magnet motors
- How to select materials
- How magnetic motors work

Discover the work of Joe Newman, Howard Johnson, EV Gray, and other researchers that worked on over-unity devices that may have worked. Gain better understanding of magnetics and how they work. Source material, patents and plans are right from Steve's classified file drawers.(121 pgs; GBC)

290009- Magnet Motors/Gen ..... 29.95



## Excess Heat with a Hydrogen Tube

**Thorsten Ludwig**

Recently a new hydrogen based device has attracted attention and has been replicated by Frolov in St Petersburg and J.L. Naudin in Paris. The device goes back on research of Irving Langmuir, who studied heat transfer from tungsten wires back in the 1920's. Langmuir, who received the Nobel prize, discovered an energy anomaly in hydrogen at pressures lower than 0.1 atm, when in contact with high temperature tungsten wire.

Nicholas Moller who recently founded the Global Institute For New Energy Technologies ([www.gifnet.org](http://www.gifnet.org)) developed the MAHG (Moller atomic hydrogen generator)- energy device on the bases of Langmuir's findings. Thorsten has recently inspected the device as well as UN secretary Cofi Annan, who visited GIFNET in April 2005 and recommended the development of this technology.

The device is quite simple and shows an overunity of 2, some report overunity as high as 21. Thorsten will present some physical explanations on why this is possible and why it is not violating the laws of physics! This is a highly inspiring simple device that everyone can build. GIFNET is not patenting the device but is taking the public domain approach to spread this technology as wide as possible. The full construction details can be taken for free from their website.

## Aqua Jewel The Crown Jewel of Water Conditioning

**Ralph Suddath**

Pouring more and more chemicals into our water in an effort to clean our water is no longer a solution to pollution. There is an easy way to solve the problem of our water becoming polluted and de-energized which costs only a fraction of what traditional water treatment methods cost. By raising the vibrational frequency of water, unhealthy bacteria are no longer drawn to it. For example, I have observed that mosquitos only lay their eggs and be drawn to water that is stagnant and de-energized vs. water that is fresh and clean.

What is needed is a paradigm shift in how we perceive and care for this precious resource, which is the foundation of all of our lives. Ideally water's vibration needs to be raised naturally, as it is in nature where life-supporting frequencies can be placed into the water. Perhaps



The unique properties of Browns Gas, still not fully understood, are begging for the experimenter to unravel its mysteries. These mysteries revolve around the fact that Browns Gas *was* water, *is* water and *will be* water... and WATER is where the real mystery lies! H<sub>2</sub>O, HOH, Hydrogen Dioxide, Adam's ale, Elixir of Life, universal solvent, call it what you want, it is necessary and fundamental to Life.

Dr John N Hait's Resonant Field Theory (RFT) can explain the nature of water, including the imprint ability of water and why Browns Gas can do what it does. This fundamental mechanism of physics is sound, reasonable, logical, and calculable. Resonance fosters stability. Resonance maintains information. Photons



the very best we can do is to mimic this natural process. By implementing technologies that have electromagnetic influences on water, it is possible not only to erase information from harmful substances, but also to induce positive frequencies into the water.

The *Aqua Jewel* is based on emerging technologies embracing these basic principles. AquaJewel technology may soon be used in place of our current chemical water treatment methods. Aqua Jewel is my device (patent pending) for treating fluids and a method for same. This water treatment system utilizes vortex action and frequency transmissions to reduce bacteria, algae, and fungus in the fluid without the use of chemicals.

## Browns Gas... Fire from Water

**Larry Oja**

resonate. Electrons resonate. Hydrogen resonates. Water resonates. Browns Gas resonates. You resonate. And you will resonate with this presentation!!

This presentation explores the subtle nature of water and Browns Gas, with examples of health applications, energy applications, machines and available kits. All attendees are invited to become inventors and researchers of Browns Gas phenomena. Be part of the excitement of the future in alternative energy and alternative health. Build or buy your own Browns Gas machine. See and feel what Browns Gas can do for you. After 40 years, the Browns Gas technology is at a point that you will want and need to be involved in this research. The Earth, climate, people are changing, literally all things are changing. Don't be the last to find out. Dare to make a difference!

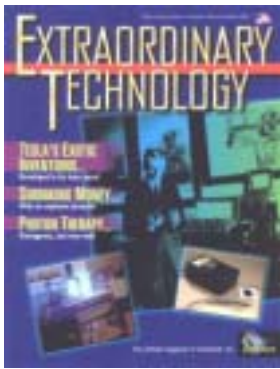

**Jan/Feb/Mar 2003 (V1N1)**

**TESLA'S EXOTIC INVENTIONS...**  
*... Developed in his later years!*  
**SHRINKING MONEY...**  
*... With an explosive formula!*  
**PHOTON THERAPY...**  
*... Outrageous... but very real!*

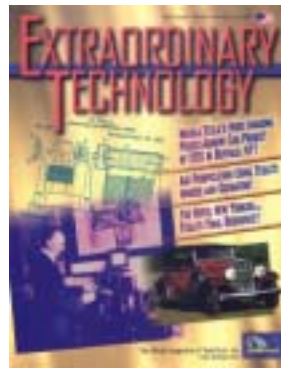

**Apr/May/Jun 2003 (V1N2)**

**TESLA'S MOST AMAZING PIERCE-ARROW CAR PROJECT OF 1931...**  
*... in Buffalo, NY!*  
**AIR PURIFICATION...**  
*... Using Tesla's Ionizer and Ozonator!*  
**THE HOTEL NEW YORKER...**  
*... Tesla's Final Residence!*

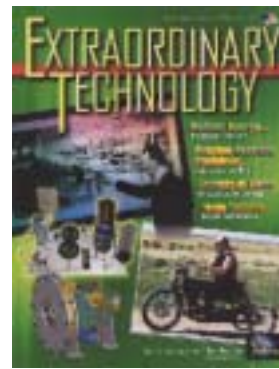

**Jul/Aug/Sep 2003 (V1N3)**

**RADIANT ENERGY**  
*The search continues!*  
**BRAXTON REACTION CYCLOTRON**  
*Applications are here!*  
**SECRETS OF WATER...**  
*Outrageous... but very real!*  
**TESLA TURBINE...**  
*Beyond the prototype!*

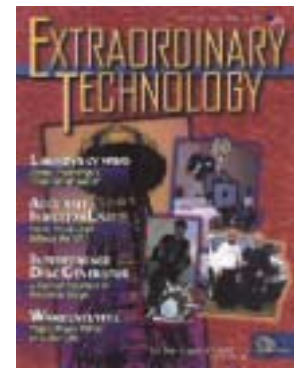

**Oct/Nov/Dec 2003 (V1N4)**

**LAKHOVSKY MWO...**  
*Zephyr Techs "Fountain of Youth"!*  
**ACCURATE INJECTION UNIT...**  
*Sonne Ward's High Mileage Secret!*  
**INTERFERENCE DISC GENERATOR...**  
*Radical Departure in Generator Design!*  
**WARDENCLYFFE...**  
*Tesla's Dream Taking on a New Life!*

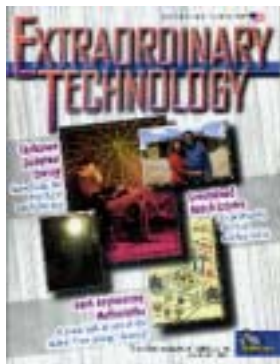

**Jan/Feb/Mar 2004 (V2N1)**

**CHUKANOV QUANTUM ENERGY...**  
*Harnessing the energy of ball lightning!*  
**BACK ENGINEERING METHERNITHA...**  
*Close look at the oldest 'free energy' device!*  
**GREENWOOD RANCH ESTATES...**  
*A community without electric bills!*

## ExtraOrdinary Technology BackIssues ARE Available!

ExtraOrdinary Technology is TeslaTech's quarterly membership magazine containing technical articles, tips, and news about the leading edge of our Scientific Revolution!!!

Single Issue \$8.95\* each!  
**COMPLETE SET (9 Issues)... \$59.95!\***

\* S/H Rates: 1st Item: \$7-US; \$9-Can/Mex; \$12-Else ... Each Add'l Item: \$2-US; \$3-Can/Mex; \$6-Else



**Tesla Tech, Inc.** Home of ExtraOrdinary Technology!

296 E Donna Dr • Queen Valley, AZ 85218

(520) 463-1994 • • FAX (801) 729-3661

[www.teslatech.info](http://www.teslatech.info)

Get all 9 issues!  
**TODAY!**

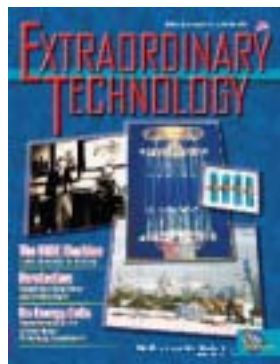

**Jan/Feb/Mar 2005 (V3N1)**

**The VIBE Machine...** *A New Dimension in Healing!*  
**Aerotecture...** *Redefining Wind Power and Architecture!*  
**Nu Energy Cells...** *Demonstrated at the ExtraOrdinary Technology Conference!*

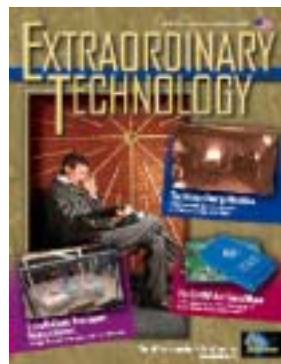

**Apr/May/Jun 2005 (V3N2)**

**Moray Energy Machine...** *Witnessed by hundreds... ruthlessly suppressed!*  
**The EarthPulse SoundWave...** *Introducing a new dimension to human consciousness!*  
**ExtraOrdinary Permanent Magnet Motors...** *Major Breakthroughs Imminent!*



**Jul/Aug/Sep 2005 (V3N3)**

**Wardenclyffe...** *Tesla's Wireless Solution to Provide Global Power*  
**Power Measurements...** *Learn Proper Technical Procedures From An Expert!*  
**BCX-411...** *A Rife Device Using Advanced Gas Plasma Technology*  
**SPECIAL...** *GREAT 2005 Conference!*

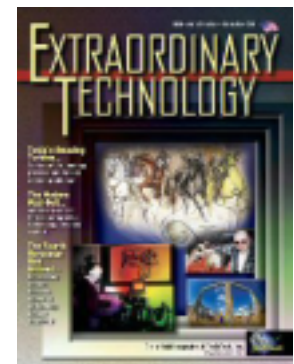

**Oct/Nov/Dec 2005 (V3N4)**

**Tesla's Amazing Turbine...** *Century old technology solution to modern problems!*  
**Modern Nazi-Bell...** *Fabled top-secret German antigravity technology is a reality!*  
**The Fourth Horseman Has Arrived...** *Devastating modern diseases appear to be fulfilling Biblical prophecy!*



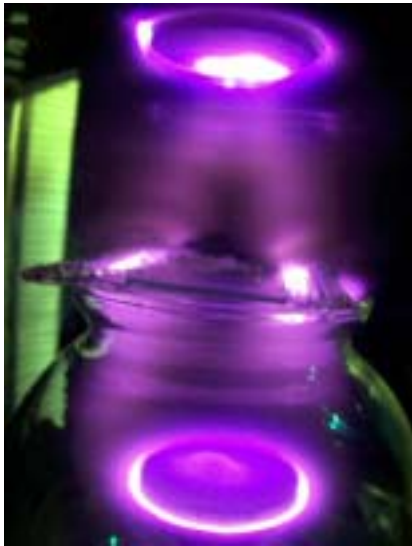

**Enhanced Energy Conversion Device (Day/Night “Solar Cell”!)**

**Mike Windell**

The newly developed *Enhanced Energy Conversion Device* (EECD) is similar to a photoelectric cell (or “solar cells”). As you know a photo electric cell which can be found in many devices such as hand held calculators provides photo electric energy to power the low current draw device. Our ambient energy cell (AEC or EECD) also provides low current draw constant ambient power to keep the main drive cell charged.

The difference is our ambient energy cell does not need visible light to produce its power as the photoelectric cells do. We have found a unique way to store usable ambient energy during night or dark periods when a photoelectric cell would be ineffective and normal batteries would have limited life. With the use of this add on ambient power source and the solar cell or battery system, such devices should extend the normal use of the main cell and its ability to do work.

It is suggested that the device shows a true manifestation of the *zero point* energy (ZPE) through manipulation of the coulomb barrier forces, as demonstrated in thin film nano-structures. The possibility of extracting energy from zero point radiation, *via* a mechanical device consisting of a charged foliated conductor was postulated in 1984 by Forward.

**Cascade Electric Discharge for ZPE Activation**

**Moray King**

High voltage electric discharges in a series cascade may produce a surprisingly energetic pulse activated from zero-point energy (ZPE). The cascade is supported by an alignment of spark gaps in series such that the spark is quenched in the first gap prior to firing across the final gap. The cascade manifests pulse sharpening and a unipolar switching event where current pulses surge through the cascade with no oscillatory ringing. Three inventors (Ken Shoulders, William Hyde, and Edwin Gray) effectively utilize electric discharge cascades and claim excessive energy production from their devices.

Shoulders repeatedly produces a micron-sized plasmoid that he calls “electrum validum” (EV). It appears to be a microscopic form of ball lightning containing more energy than what was stored on the originating capacitor. A series cascade of EV launchers produces centimeter sized EV containing a dangerous amount of energy. Triggering EVs may act as coherent forms, coupling to successive launches to form a plasmoid vortex ring.

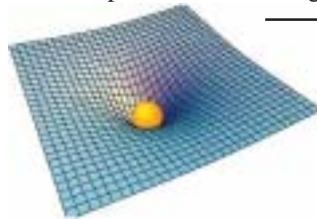

For decades, researchers and experimenters have theorized that energy can be extracted from space to power motors or mechanisms that would be useful to mankind.

Our present use of fossil fuels is inefficient and generates massive quantities of undesirable by-products in the form of gases and solids such as CO<sub>2</sub>, CO, SO<sub>2</sub>, NO<sub>x</sub> compounds and ash in addition to waste heat.

Machines have been invented that have a net power gain. They derive the additional energy from the space surrounding them. All space is capable of storing and trans-

**Cascade Discharge**



Pure Unipolar Switch

Creates Large Ball Lightning (EV)

Hyde’s mechanical field chopper is a simplistic waveform generator reminiscent of the 1930s. Using a large number of thin stator segments at sufficient rotor speed, Hyde claims to observe anomalous voltage spikes coming from each of the stator segments. A special rectifier circuit would absorb these spikes and store excessive energy on output capacitors. Hyde claimed to have sufficient output power to make his device self running.

A cascade discharge trigger circuit drives Gray’s plasma tube. Polarized corona builds up within the tube’s cathode. The corona is excited from a spark gap within the tube, which may launch a plasmoid in response to the sharp voltage spike from the triggering cascade. The interaction of the plasmoid with the cathode grid corona yields a highly energetic polarization pulse which manifests a “cold current” characteristic: Appreciable power is guided by the circuit wires without heating them. Here the wires seem to be guiding a polarization displacement pulse in the ZPE surrounding them.

**The Power In Space**

**Ron Nott**

mitting static and dynamic electric, magnetic and electromagnetic energy. Understanding the nature of space that allows this energy storage will promote further development of devices that have a net power gain.

More than a century ago, Faraday demonstrated the static storage of energy in electric and magnetic fields. Then Maxwell explained the propagation of dynamic electromagnetic energy through space after which Tesla explained electromagnetic resonance.

Energy exists in all space. To utilize it, we must understand the mechanisms by which it is stored, both by static and dynamic mechanisms.



# ExtraOrdinary Products

Home of the Best Kept Secrets of Science

## Introducing **FLUID RX**

### The "One Drop Oil Test!"

**Fluid Rx Instant Lubricant Test** is a patented fluid test that measures the amount of sludge in a lubricant or oil. **Fluid Rx** testing provides simple and accurate verification that a fluid should be changed! Simply place a drop of the sample fluid or lubricant on the **Fluid Rx** tester (filter paper) then compare the findings to the **Fluid Rx** ISO analysis chart. In seconds **Fluid Rx** provides an analysis of the sample.

The kit can test six types of fluid/lubricants:

- Crankcase Motor Oil
- Brake Fluid
- Power Steering Fluid
- Transfer Case Gear Oil
- Transmission Fluid
- Differential Gear Oil

As fluid test specimens percolate through the unique Fluid Rx filter paper, bands and/or zones of different colors, densities, even unwanted wear metals and debris form a chromatogram. Changes in the appearance of the zones or bands are a clear indication that something in the lubricant has changed. A closer look at the zones, their unique formation, and the debris fields contained therein reveal high particle counts that can be correlated to ISO Code. Fluid Rx chromatograms provide a measure of sludge and dispersant properties that is correlated to laboratory analysis: **New/Good, Change, Bad**. Simply compare the Fluid Rx chromatogram to the Fluid Rx ISO analysis chart.

Each kit contains instructions, ISO comparison charts for the six fluids, and materials for six tests of each fluid. Additional sheets of Motor Oil Test Pads are available. Each sheet is good for 6 tests.

990010 - Fluid RX Personal Test Kit .... 9.95

990011 - Add'l Motor Oil Test Sheet ... 3.00



## MagnaGuard

### Inexpensive Engine Protection System

Even under the best conditions, with meticulous maintenance, your engine sheds tiny particles of metal grit in the oil. Since oil filters are designed to pass oil freely to provide adequate lubrication for your engine, only particles of grit 20- 30 microns or larger are, will trapped in the filter's porous element. **MagnaGuard** added to these same filters controls particle contamination down to 0.5-microns... about 40 times more grit than your filter alone!

A clean engine runs better, lasts longer, gets higher mileage, and reduces pollution. Independent lab tests document an 18% reduction in toxic tailpipe emissions with **MagnaGuard**. Install **MagnaGuard** today and start reducing overall maintenance and operating costs.

990003 - Magna-Guard ..... 7.99

The Original  
All-In-One  
Formula

Synthetic Lubricant  
Concentrate



**Liquid Ring** brings back power and performance to a worn, weak engine while reducing emissions at the source. Its innovative Lube-Logic multi-action formula senses and adapts to your engine's performance needs for high or low mileage engines. First, the formula builds up compression and stops smoking that occurs due to worn engine parts such as pistons, piston rings, and cylinder walls. Then, its protective coating becomes bonded and does not drain back into the oil pan when the engine is off. (**Liquid Ring** does not contain Dupont teflon.)

Easy to apply, **Liquid Ring** can be used as strictly an occasional engine overhaul treatment or for smog reduction. When used as a smog reducer (the preferred method), one will constantly reap the overhaul treatment benefits. As long as **Liquid Ring** is present in the engine, the catalyst will help reduce smog.

990002 - Liquid Ring (1qt) ..... 39.95



## T.T.-L

### Better than VIAGRA!!!

Advanced Soviet Bio-technology...

**T.T.-L** is an original all natural, non-hormonal preparation of *Tribulus Terrestris* L—a natural steroid. Active ingredients are steroidal saponins of the furostanol type, isolated from the puncture weed. Used around the world for years as folk remedies for many ailments and conditions in addition to those related to sexual functions, body builders use it on a regular basis to increase stamina!

#### Supplement Benefits:

- Arthritis Pain Relief
- Increased Lean Muscle Mass
- Impotence - Infertility
- Hair/Nail Repair & Growth
- Regulation of Blood Pressure
- Cholesterol Level Management
- Immune & Respiratory System Support
- Rejuvenation & Increased Stamina

The strongest formulation on the market, each Capsule contains 40% Saponins. **Guaranteed for relief of arthritis pain within 21 days** when taken as instructed.

900001- TTL Ext (btl of 90) ..... 39.95

### Start Banishing Disease Today ...

with unlimited amounts of colloidal silver...  
it's safe and heals with the power of nature!

## Pocket Sized Colloidal Silver Generator

Note: These units are for personal *experimental* use only.

Silver, commonly valued for its monetary value, and referred to poor man's gold, has been used since ancient times as an antiseptic and cure for many diseases. Then, with emergence of the pharmaceutical companies it disappeared...

Colloidal Silver, a powerful natural antibacterial liquid can be applied externally, and used throughout the house. It costs only pennies per cup to produce with the pocket generator, which produces colloidal silver at 3-5 ppm with particle size of 0.005-0.015 microns. This generator provides an adequate amount for personal use for up to a year! Add'l information/instructions provided. Battery not included.

990002- Pocket Silver Generator .... \$8.95





## “Joe Cell” Suppressed Technology from *the Land Down Under* Vernon Roth

The *Joe Cell*, a truly emergent technology was developed more than thirteen years ago in Australia. Since its creation this device and its researchers have suffered ridicule and attack, as well as misunderstanding and infamy. But those who study and build these devices attest to their authenticity and ability to create motive power and alternative energy.

The *Joe Cell*, which has gained notoriety because of recent efforts to quench its use and research, is difficult to understand. Some claim it is a hydrogen generator; others claim it's an orgone accumulator, able to tap the aetheric flow. Still others believe it is something more...

Physically, the *Joe Cell* is a chamber which, using specially ‘charged’ water from certain sources, emits an energy that is capable of powering engines! After the initial charging stages, the cell becomes an environment that draws aether/ life-force energy and packs it into a usable location, allowing access into the infinite sea moving around us. Our research has shown phenomenal uses in non-Hertzian energy, matter manipulation, healing, well-being and longevity.

At the conference, the stages of charging water will be presented, as well as tips for construction and experimentation, because we believe it is vital that a researcher build and create their own cell. Also discussed will be methods for obtaining, refining and even creating seed water for your cell. Various cells and chambers will be shown and the elements to fill them will also be displayed.

## The XPOD A Spark Gap Method of Harnessing Radiant Energy

William S. Alek

Excess electrical energy has been discovered in spark gaps using Carbon/Graphite—Thoriated Tungsten rods with a coefficient of performance (COP) greater than 100% across the gap. A Wimshurst Generator is used as a primary high-voltage dynamo. A Tesla-like step-down transformer with a ferrite rod is used to efficiently reduce the high-voltage down to safe practical levels, which can easily be distributed and measured. The device shown generates successive electric discharges or Electrum Validum (EVs) discharges are generated, and their associated energy is collected in a 10uF low loss capacitor during a given period of time.

My conclusion is the Carbon Arc is performing as a NEGATIVE resistance-like device in every test case. The bottom line is that there is MORE energy charging up capacitor C1 with the spark gap than



without, and the greater the primary inductance, the greater the amount of energy that is collected. Therefore, the Carbon Arc looks very promising as providing a source of excess energy, once properly harnessed.

There will be a live demonstration of devices that harness radiant energy emitted from Carbon Arcs. These devices collect the excess electrical energy and store it in capacitors and batteries. One of these devices called SmartPAK computes and displays the COP in real-time by measuring the voltages and currents going in and out of the system.



## Power Factor Correction Makes Every Watt Count!

Forrest Pittman

An uncorrected power factor is inefficient and cheats the consumer of the full benefit of the electricity he has purchased!

For some reason, a lot of engineers and technicians seem to have a problem with understanding *power factor correction*. However, not understanding what a *power factor* is and how to correct it can lead to overcharges on YOUR electric bill. An incorrect power factor is like driving a poorly tuned vehicle... the car moves, but you pay for a lot of extra gas!

As your local utility distributes electricity over the grid, line losses occur and the current tends to arrive sooner than the voltage. In other words, the voltage lags the current and the actual power available is not as great as electrical meters based on wattage claim. Early efforts to correct this phase difference were centered on the fuse box. However,

as power factor correction became popular with major companies, the utilities changed their meters from watt measurements to reading current consumption thus causing an actual increase in utility bills where the power factor was corrected at the fuse box. This has forced power correction efforts to be decentralized and performed on each individual motor.

This hands-on presentation will teach you how to properly read a KVAR meter to measure how much your voltage is lagging your current. Then you learn several different techniques on how to correct the power factor on various electrical motors. Most important of all, you will discover how easy this intimidating topic is to understand and master.



**Jul/Aug/Sept 1999**  
Volume 3 Issue 3

**WARDENGLYFFE DESTROYED  
BIOELECTRIC FIELD ENHANCE  
GEET LAWNMOWERS**

100111

- Critical Thinking Skills... Prerequisite to Breaking the Mold!
- ECHELON: Big Brother 2000!
- The Skeptics Corner.Free Energy Conspiracy
- Backyard Plasma Technology:  
*Free GEET Small Engine Plans...*
- Vacuum Energy Vortices
- Two Radiant Energy Devices Hold Greatest Promise!
- The Fall and Decline.. Tesla's Darkest Hours
- The Bio-Field Experience.. From Down Under
- The Wet Cell



**Apr/May/June 1999**  
Volume 3 Issue 2

**WIRELESS POWER...  
100 MPG...  
ATOMIC IODINE...**

100110

- Trust Me...Independent Inventor's Dilemma!
- Ultimate Engine Treatment....
- Thermal Catalytic Cracking... Key to 100 mpg
- Backyard Plasma Technology... 5KW Generators Converted to GEET
- Magnetic Vortex Machine...
- The Skeptics Corner... How to convince me to invest in Joe Newman
- Terrestrial Night Light
- Spiritual Healing... with Natural Science
- Atomic Iodine
- MSM Miracle



**Jan/Feb/Mar 1999**  
Volume 3 Issue 1

**MAGNIFYING TRANSMITTER  
BROWN'S GAS...  
BIOMAGNETICS...**

100109

- RF Weapons... Exotic Weapons Pose Threat
- Fluxless Brazing Rods.... Every Exotic Toolbox Should Have Them
- The Incredible Secret of Brown's Gas
- Granite.. Construction Material of the Gods
- Backyard Plasma Technology... Lawnmowers Converted to GEET... The Technology Works
- Skeptics Corner... Banned from Cutting Edge
- Practical Magnifier Construction Principles...
- Electromagnetic Pollution
- The Scope of Biomagnetism
- Immunocal... A Natural GSH



**Oct/Nov/Dec 1998**  
Volume 2 Issue 4

**ANTI-GRAVITY SQUADRON  
THE VOLKSWAGEN GEET  
EGYPTIAN HIEROGLYPHICS**

100108

- Suppression... Business as Usual in .. DC
- Electrogravitics.. Research in the 1950s
- Hamel Technology.. Poor Man's Searl Device
- Ion Propulsion... Building a Working Model!
- Brown's Gas... Key to a Hydrogen Economy!
- GEET Volkswagen Retrofit R&D Report
- Cold Fire
- Resonance Frequency Therapy. Comes of Age
- Effects of Magnets & Their Two Pole Energies
- Classic Restraints... to Novel Science

**Available Backissues of *Exotic Research Report* --\$8.95\* ea**



**Exotic Research Collection**

Get all 7 remaining issues of this highly collectible magazine which is no longer being published. Although Exotic Research is no longer with us, much of the information contained in these magazines is still just as valuable.

**What is an issue worth? Immeasurable...** well-referenced articles contain detailed information... and plans for a variety of devices. Only seven issues remain. Volume 1 has been completely SOLD OUT!

**100112 - SPECIAL PRICE .....\$49.95!\***

**ORDER TODAY!**

*Offer good only while supplies last!*

**\*Shipping/Handling Rates**

1st Book: \$6-US; \$8-Can/Mex; \$12-Other  
Each Add'l Book: \$2-US; \$3-Can/Mex; \$6-Other  
Collection: \$10-US; \$12-Can/Mex; \$18-Other



**Jul/Aug/Sept 1998**  
Volume 2 Issue 3

**TESLA TURBINE TEST STAND  
SPHERICAL CHEMICAL TABLE  
BAHLMANN POWER WHEEL**

100107

- Energy Independence. Reality/ Fantasy
- 1998 Conference Speaker Contacts
- A Fully Functional Turbine Test Stand
- GEET... Advanced Technology...
- *Dumanis Kyklos...* The Power Wheel
- Spring Atom.New Atomic Theory by Magnets
- Table Old Square & Roll in the New Sphere..  
*The Basis for Quantum Disc FVY.*
- The Electro-Acuscope/Mycopulse
- TTL... Secret Soviet Performance Enhancer
- STEVIA... Natural Alternative to NutraSweet
- Wagging the Dog! The al-Shifa Pharmaceutical Factory Raid



**Apr/May/June 1998**  
Volume 2 Issue 2

**GEET TECHNOLOGY  
INTEGRATRON  
COLD FUSION**

100106

- Zero Tolerance = Zero Sense
- TWA Flight 800
- Wooden Lightning
- New Radiant Energy Devices
- Cold Fusion Reality... The Neltron Way
- GEET... Advanced Technology Today
- Prep of Pre-Mixed Gas-Plasma Phase Fuels
- The Integratron Metaphysics/Physics
- Sacred Geometry Behind Integratron
- The House of the Future..Is Here Now!
- The Secret of Negative Ions...
- Hormonal Imbalance Survival
- Chelation Therapy... Fountain of Youth



**Jan/Feb/Mar 1998**  
Volume 2 Issue 1

**PHOENIX LIGHTS  
PLASMA STEAM  
PLASMA RESEARCH**

100105

- Code of Honor... A Man's Word is His Bond
- The Virtual Studio Network
- Plasma Steam
- GEET - From theory to production
- Plasma Research-Unusual Reaction of Mass 5
- Making Precious Metals at Home: Silver to Gold - Wet Methods
- Ethereal Electrogravitics
- Bathing with Herbs... For better health
- Banishing Disease... with colloidal silver
- Arthritis! End the Pain Today!
- Phoenix Lights: "Rodney King" case of UFO
- Directed Energy Weapons Research

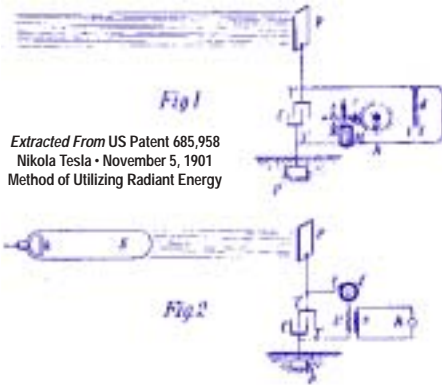

Extracted From US Patent 685,958  
Nikola Tesla · November 5, 1901  
Method of Utilizing Radiant Energy

## Radiant Energy and Its Role In Our Free Energy Future

**Peter Lindemann, DSc**

Nikola Tesla's Magnifying Transmitter, T. Henry Moray's Radiant Energy Device, Edwin Gray's EMA Motor, and Paul Baumann's Testatika Machine all run on Radiant Energy. This natural energy form can be gathered directly from the environment (mistakenly called "static" electricity) or extracted from ordinary electricity by the method called "fractionation." Radiant Energy can perform the same wonders as ordinary electricity, at less than 1% of the cost.

As you will learn, it does not behave exactly like electricity, however, which has contributed to the scientific community's misunderstanding of it. The common feature connecting all of these discoveries, is that they use a small amount of one form of energy to control or release a large amount of a different kind of energy. Many of them tap the underlying Æther field in some way; a source of energy conveniently ignored by "modern" science.

Tremendous breakthroughs in energy creating technology will provide society with the opportunity for a complete redistribution of wealth and economic power! Thus the appearance of Free Energy in the public domain occur with the simultaneous appearance of a new, worldwide social contract. Free Energy technology will raise all of the world's poor out of economic slavery, setting the stage to settle other political, racial, and religious disagreements among the world's people.

## Antigravity Effects In Nature

**Dan Davidson**

The gravity flows that originate from higher levels of creation will be presented and shown how they establish the matrix for the manifested physical universe as we observe it. A few examples will be discussed: in the plant kingdom, at the atomic level, the solar planetary resonance level and the insect domain. This research supports the Global Scaling developments by Dr. Helmut Mueller that show the natural universe is sustained and supported by these creative forces that permeate the universe from the subatomic to the galactic and super-galactic levels. The source of these creative "flows" will also be briefly discussed.

There are well researched (i.e., proven) antigravity effects in Nature in the material realm as well as the plant and insect kingdoms. In the insect realm there is strong evidence that the June bug beetle wing was used in the Grebennikov gravity platform to achieve the spectacular effects recorded by Grebennikov includ-



Scanning Electron Micrograph of a June Bug Inner Wing at 1000X by Dr. Ted Loder (University of New Hampshire).

ing apparent time travel, forcefield generation, and high speed travel. New detailed scanning electron microscope pictures of the nano structures of the wings of the common June bug will be discussed and show how they could be the long sought after "bug" that Grebennikov used to build his flying gravity platform. There is a strong correlation of the nano structures of the wings with the Shape Power effects discovered by the author and the Stowe gravity theories of the aether.

Plants and especially trees exhibit anti-gravity effects and have been measured. This analysis shows that plant branching and nodes are the result of horizontal and vertical gravity waves that govern the structure of plants. Included in this research paper will be the frequencies, wavelengths, and wave speeds.

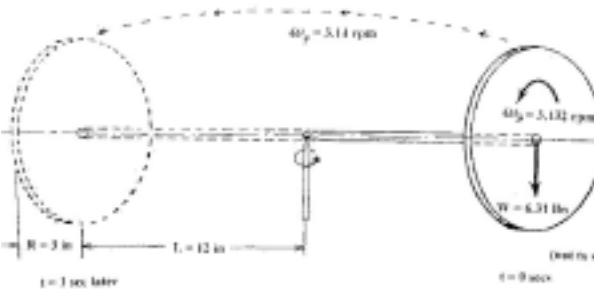

## Inertial Propulsion

**The Holy Grail Of Space Travel**

**Harvey Fiala**

This paper will give a definition of Inertial Propulsion and a brief summary of some of the different approaches that have tried achieve it or claim to have achieved it. In a strict sense of the word, Inertial Propulsion is the ability to move or accelerate a body in some direction without the use of a propellant or the application of an external force.

The energy required to accomplish this must be contained within the body (for limited movement or acceleration), or the body may generate the required energy by harnessing energy that may be present in the aether, whether it is electrical, mag-

netic, nuclear, gravitational, acoustic, or zero point energy for unlimited movement or acceleration. A simple example of Inertial Propulsion moving 6.31 lbs a distance of 24 inches using Natural Precession of a simple spinning disk as shown above. The presentation reveals additional details of this and other devices.

Any form of energy present in the vicinity of the body may be said to exist in the aether occupied by the body unless the energy is shielded from entering into that space. A brief account of the NASA Breakthrough Propulsion Physics Project will be given.

# ORDERING INSTRUCTIONS

**Please include your phone number!**

This helps us to contact you in the event of a discrepancy or problem. Your privacy and confidentiality will be respected otherwise. It has always been, and always will be, our policy to NOT sell our membership and customer mailing lists.

**Send special questions and comments** on a separate piece of paper, so that the processing of your order is not slowed down. Although we may not be able to respond to your comments directly, we do welcome them and read every one of them — and often, changes and new books are the result of an inquiry. Technical questions are usually better handled if directed to our magazine, **ExtraOrdinary Technology**, as a "Letter to the Editor."

**We attempt to keep all books in stock.** However, there are occasions when demand outpaces supply. Accounts are credited at the time an order is placed. If a book is out of stock, it will be backordered and sent to you as soon as it arrives. If a book has been discontinued, a refund will be sent immediately.

**We try to keep our Shipping and Handling charges as low as possible.** The US Postal Service's constant and ever accelerating rate changes have destabilized the shipping market. Currently, in our most recent shipping schedule, we have decided to ship ALL books by bookrate or surface, unless specifically requested otherwise. We are looking into UPS as an option... but they do not deliver to PO Box addresses.

**We have a variety of payment options.** In addition to accepting the major credit cards shown, we also accept checks, postal money orders, money orders and Federal Reserve Notes (ie. cash in US dollars).



**Dissatisfied?** If there is a problem with your order, please notify **TeslaTech, Inc** at **(520) 463-1994** immediately.

*Thank you for your support!*

*Orders processed and shipped within a week*

Overseas orders... Please address order as it is to appear on the package!

## TeslaTech, Inc Order Form

Qty	Catalog Number/Item Description (Title)	Price	Cost

**Shipping/Handling**  
 1st Item: \$7-US; \$9-Can/Mex; \$12-Other  
 Add'l Item: \$2-US; \$3-Can/Mex; \$6-Other  
 Tape Sets: \$20--US • \$25--Can/Mex • \$40--Else

**Prices and availability are subject to change without notice!!!**  
 All titles are subject to be discontinued without notice due to availability! Prices occasionally change between the time the catalog goes to press and the time you order. *Your invoice will show the current price regardless of what might be in the catalog. If your edition is more than a year old, write for a current catalog.*

Send with check or money order in United States funds to:

**TeslaTech, Inc**  
 296 E Donna Drive  
 Queen Valley, AZ 85218  
 United States of America

Name: \_\_\_\_\_  
 Address: \_\_\_\_\_  
 City: \_\_\_\_\_ State: \_\_\_\_\_ Zip Code: \_\_\_\_\_  
 Country: \_\_\_\_\_ Phone: \_\_\_\_\_

**Credit Card Orders: (520) 463-1994 ... FAX(801) 729-3661**

Acct Nbr: \_\_\_\_\_ Exp Date: \_\_\_\_\_

Total Cost  
 - 10% Discount (members only)  
**SUBTOTAL**  
 6.6% Sales Tax (AZ Only)  
 Shipping/Handling  
**AMOUNT DUE**



**Order BOOKS ONLINE!**  
[www.teslatech.info](http://www.teslatech.info)

Check periodically for our new releases of books and merchandise to our website... it's updated monthly!

**TeslaTech Mini Survey**

I would be interested in:  
 \_\_\_\_\_ TeslaTech T-Shirts  
 \_\_\_\_\_ 2007 Conference



# 2006 ExtraOrdinary Technology Conference

Conducted by *TeslaTech*  
Salt Lake City, UT • July 27-Jul 30, 2006

**Register Today!**  
**(520) 463-1994**

Be A Friend! Bring One!

## CONFERENCE PREREGISTRATION FORM

**ADDICTED TO OIL? We can help... and you can too! Attend the conference and be part of the *Science of the FUTURE!***

Nikola Tesla set the stage for unparalleled technological advances in the 20th Century and the new millennium. In the tradition of Tesla, many of our researchers will be presenting new concepts that go against the status quo. Speaking slots are limited with priority going to those who have **WORKING HARDWARE!** Categories include **Tesla Technology, zero point energy, plasma technology, Tesla Turbines, fuel cells, implosion, energy medicine, emerging health issues,** etc. We challenge you to come and see many of these advanced concepts demonstrated at this conference.... *many of them are so unbelievable, you have to see them for yourself.*

**This is a great opportunity to meet others who share your interests!** Attending conferences is the best, and most economical, way of developing your network of professional contacts.... *Get the inside technical information you will not find on the internet!!!!* -- **Send in your preregistration early to get the discounts offered!**

### Conference Notes:

- **Videotapes.** Professional quality video tapes will be available during and after the conference. *Private taping is not allowed.* Conference fees **do not include** tapes.
- **Family Discounts.** Spouse rates available to immediate family accompanied by *members.*
- **Individual Sessions.** Individual session rates available at the door on a *space available* basis only. Individual sessions will total at least \$280.00 if each session was purchased separately.
- **Hotel.** Make reservations early to get our special group rate (\$75)!

#### HAMPTON INN

10690 S Holiday Park Dr  
Sandy, UT 85218

**(801) 571-0800**

**Ask for TeslaTech rate!**

- **Refund Policy.** Nonemergency refunds are subject to a 10% cancellation processing fee.

Send in with check or money order in *United States funds* to:

**TeslaTech**  
296 E Donna Drive  
Queen Valley, AZ 85218

### Conference PreRegistration Rates

Type Attendee	Rate	# Attend	Cost
Member/Nonmember	\$249.95		
Spouse	\$199.95		

**List spouse/student/additional attendees:**

\_\_\_\_\_

\_\_\_\_\_

#### TeslaTech Members Registration Discount Rates

- 25%-Members registered before Mar 30
- 20% -members registered before May 1
- 15% -members registered before June 30
- 10% -members registered before July 10

**Register Early for BEST Discount!!!**

**Register Early!!!!**

Door registration subject to space availability!

#### Conference Fees:

Total: \_\_\_\_\_

— Discount: \_\_\_\_\_

Subtotal: \_\_\_\_\_

TeslaTech Membership: \_\_\_\_\_

Total: \_\_\_\_\_

#### Annual TeslaTech Membership Rates

Discounts do not apply to Membership Rates!

**\$30.00--US • \$35.00--Canada/Mexico • \$55.00 --Elsewhere**

Name: \_\_\_\_\_

Address: \_\_\_\_\_

City: \_\_\_\_\_ State: \_\_\_\_\_ ZipCode \_\_\_\_\_

Country: \_\_\_\_\_ Phone: \_\_\_\_\_

**Or CALL (520) 463-1994 or FAX (801) 729-3661 with your MASTERCARD, or VISA order!**

Account Number: \_\_\_\_\_

Expiration: \_\_\_\_\_

Check out our website at : <http://www.teslatech.info>



# Not a Member? Join Today!

## Discover the Best Kept Secret in Science!

### Member Benefits

- *ExtraOrdinary Technology* (qtly)
- Mail Order Discounts
- Conference Fee Discounts

*TeslaTech* champions and nurtures advanced concepts and products in science and technology. Our publications and conferences provide independent inventors and researchers with a credible platform to introduce new, advanced concepts, inventions and discoveries to the world – many of these concepts originated with Tesla at the turn of the 20th century. Research materials related to science and technology are available to the general public through our catalogs.

### – Annual Membership Fee

- \$30-United States
- \$35-Canada/Mexico • \$55-Elsewhere
- Lifetime US Membership \$500**

### \$75 DELUXE MEMBERSHIP PACKAGE

(US Memberships Only)

- 1- year Membership
- All 9 Backissues of *ExtraOrdinary Technology*
- Free Copy of *Letter of Petrus Pergrinus*

### ExtraOrdinary Technology Backissues

SPECIAL PRICE  
9-Issue Set

**\$59.95! \*..... 102003**

\* Shipping/Handling Additional

**Order When Joining  
For FREE Shipping!**

### Backissues available...

- V1N1 - Jan/Feb/Mar 2003
- V1N2 - Apr/May/Jun 2003
- V1N3 - Jul/Aug/Sep 2003
- V1N4 - Oct/Nov/Dec 2003
- V2N1 - Jan/Feb/Mar 2004
- V3N1 - Jan/Feb/Mar 2005
- V3N2 - Apr/May/Jun 2005
- V3N3 - Jul/Aug/Sep 2005
- V3N4 - Oct/Nov/Dec 2005



Credit Card Orders Contact:

## Call (520) 463-1994

[www.teslatech.info](http://www.teslatech.info)



## TeslaTech, Inc

296 E Donna Dr • Queen Valley, AZ 85218

PRESORTED  
STANDARD  
US POSTAGE PAID  
PHOENIX, AZ  
PERMIT NO. 1161



**2006 ExtraOrdinary Technology Conference ... Salt Lake City, UT ... Jul 27-Jul 30**

[www.teslatech.info](http://www.teslatech.info) ... Energy • Medicine • Technology For the Future ✌